



Undermount Model Single Bowl RVRU17179

Specifications

FEATURES:

- 18 (1.2mm) gauge nickel-bearing stainless steel
- 9" (229mm) deep
- Polished Satin finish
- 3-1/2" drain opening
- Sound dampening pad with spray undercoating
- Minimum cabinet size: 24" (610mm)
- Sink complies with ASME A112.19.3-2008 / CSA B45.4-08



These sinks are listed by the International Association of Plumbing and Mechanical Officials as meeting the requirements of the Uniform Plumbing Code and the National Plumbing Code of Canada.

OPTIONAL ACCESSORIES:

- Bottom Grid: GFOBG1717SS
- Cutting Board: LKCBF17HW
- Drain: S1
- Mounting Clip: RVUCLIP8

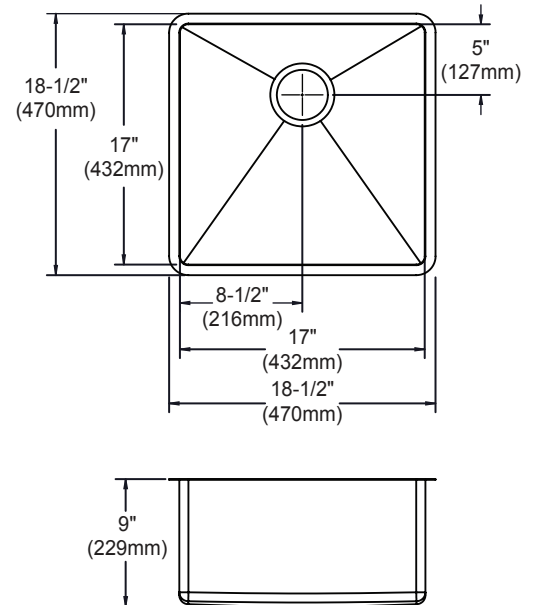

Installation Profile of RVRU Models

The template provided with each RVRU sink provides the only type of installation recommended by Revere.

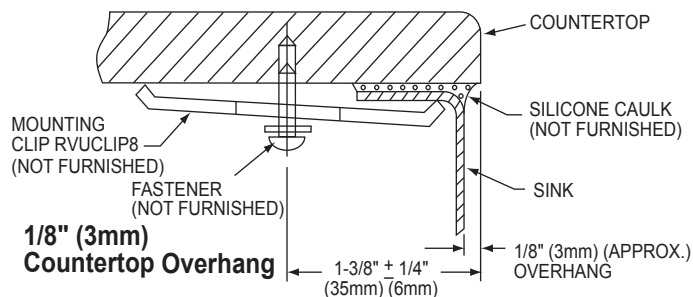

NOTE: THIS UNDERMOUNT SINK IS DESIGNED TO MOUNT TO SOLID SURFACE (NON-LAMINATE) COUNTERTOP ONLY.

In keeping with our policy of continuing product improvement, Revere reserves the right to change product specifications without notice. Please visit reversesink.com for most current version of Revere product specification sheets.

This specification describes an Revere product with design, quality and functional benefits to the user. When making a comparison of other producers' offerings, be certain these features are not overlooked.

Revere • 2222 Camden Ct. • Oak Brook, IL 60523 • reversesink.com • Tel: (800) 225-8585 • Fax: (630) 645-4447